

WELCOME. LET'S GET YOU PRINTING.

ACCESSORY CHECKLIST

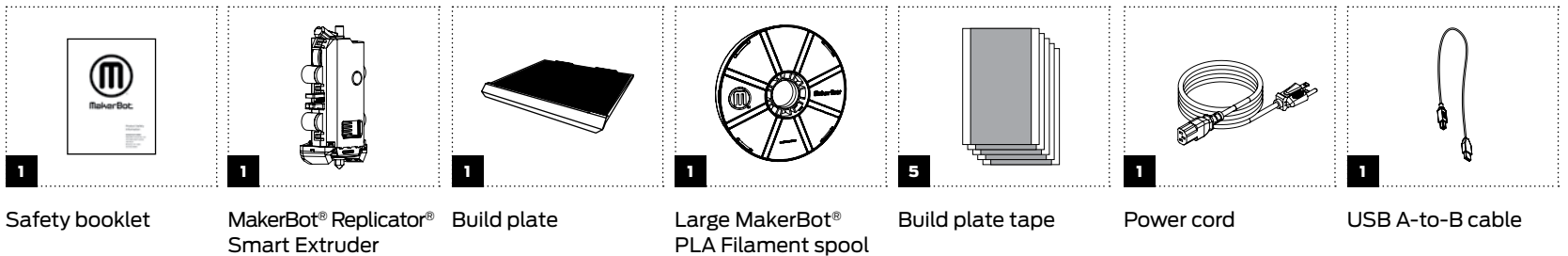

GETTING TO KNOW THE CONTROL PANEL

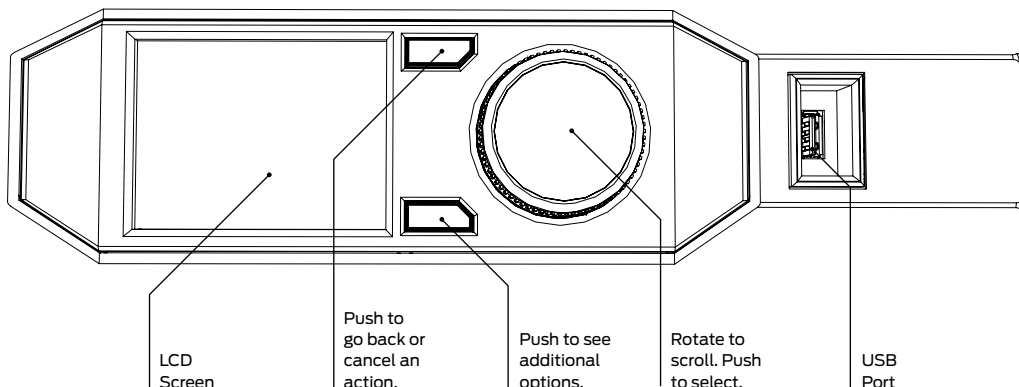

MAKERBOT DESKTOP

To prepare files for your MakerBot Replicator to print, you'll need MakerBot Desktop.

DOWNLOAD

Go to makerbot.com/desktop to download the software for free.

INSTALL

Open and run the MakerBot Desktop installer.

OPEN

Start up MakerBot Desktop and choose how you will connect to your MakerBot Replicator. The app will guide you through the rest of the setup process.

DOWNLOAD THE USER MANUAL

For more in-depth information on setting up and using your MakerBot® Replicator® Desktop 3D Printer (Fifth Generation Model), download the full MakerBot Replicator User Manual online. Available languages include English, French, German, Spanish and Japanese.

w makerbot.com/um_rep

Visit our Support page for more advanced information on the MakerBot Replicator and MakerBot® Desktop.

w makerbot.com/support

SUPPORT

The expert MakerBot Support team is standing by to help you out with any issues you may encounter while using your MakerBot Replicator.

e support@makerbot.com

t +1.347.334.6800

MakerBot Support is available Monday through Saturday 9am - 6pm Eastern.

The MakerBot Replicator Desktop 3D Printer (Fifth Generation Model) is covered by a Limited Warranty. For terms and conditions, see makerbot.com/legal

1. REMOVE PACKAGING MATERIAL

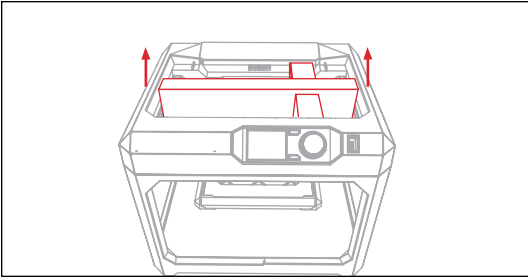

2. REMOVE CLIPS

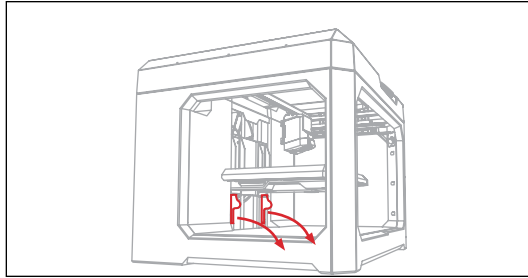

3. INSTALL SMART EXTRUDER

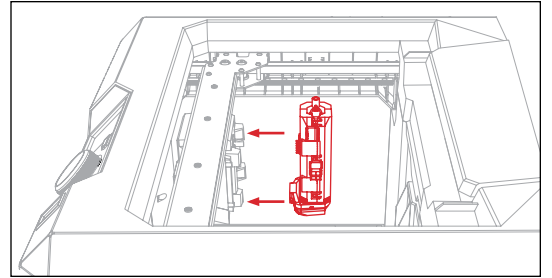

4. LIFT FILAMENT DRAWER

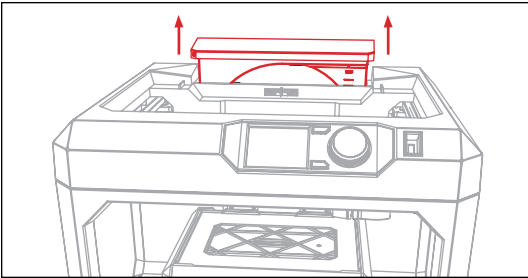

5. LOAD FILAMENT SPOOL

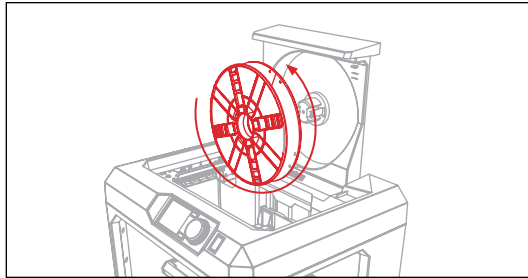

6. ROTATE SPOOL TO ROUTE FILAMENT

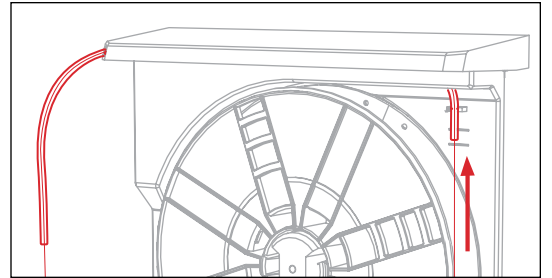

7. MOVE TUBE ASIDE AND CLOSE DRAWER

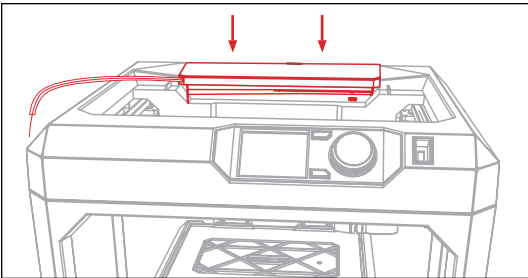

8. APPLY TAPE TO BUILD PLATE

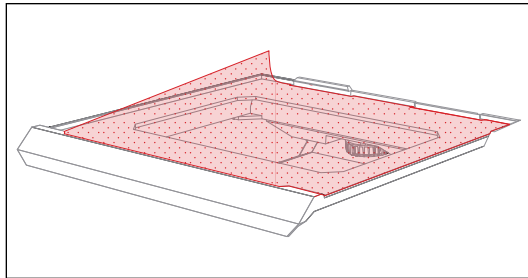

9. SLIDE BUILD PLATE INTO PLATFORM

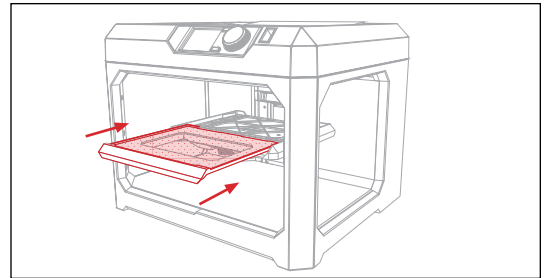

10. PLUG IN AND POWER ON

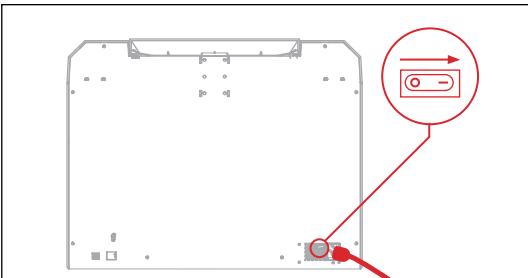

11. PRESS DIAL TO START SETUP

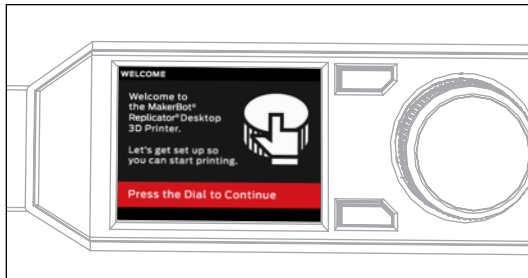

12. LEVEL THE BUILD PLATE

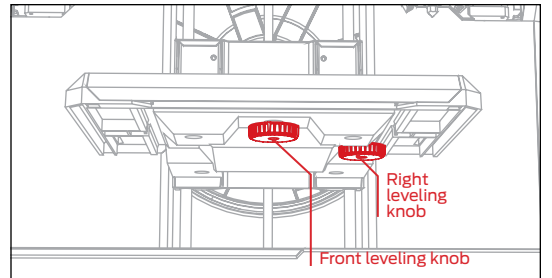

13. LOAD FILAMENT

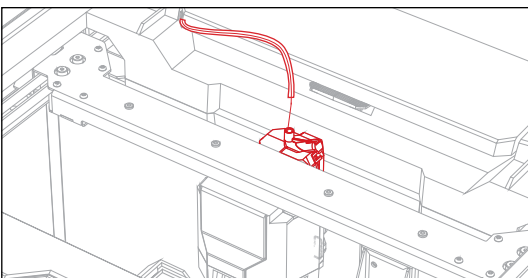

14. CHOOSE A TEST PRINT

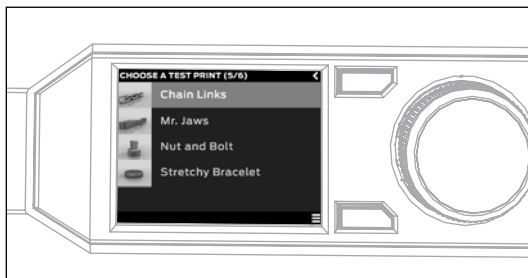

FOR MORE INFORMATION
Download the User Manual
makerbot.com/um_rep